

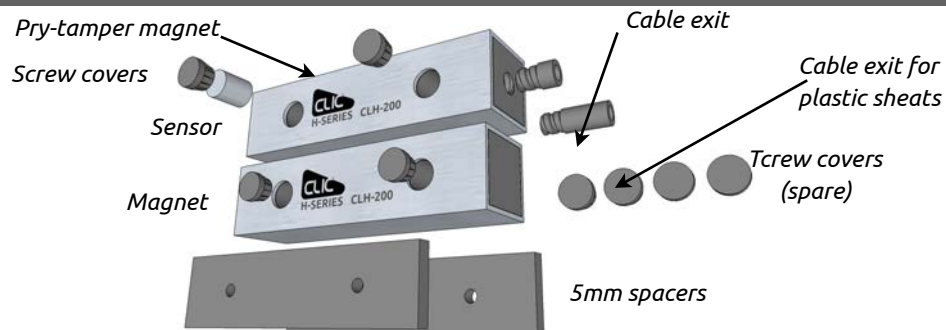

## 1. TECHNICAL FEATURES

- \* Based on patented Magnasphere® technology, used under license
- \* Dimensions in mm magnet/sensor (l x h x d): 100 x 25 x 25
- \* 4-wire flying lead:
  - Term. 1/2: primary contact, closed with magnet in secure position.
  - Term. 3/4: pry-tamper
- \* Electrical parameters: (max., per circuit): 30VDC, 250mA, 0.25W
- \* Anodized aluminum case, full potting, suitable for external use
- \* Certified IMQ-SISTEMI DI SICUREZZA: Grade 3, Environmental Class II according to EN 50131-2-6:2008-09.

## 2. PACKAGE CONTENTS



## 3. PREPARING THE SENSOR FOR INSTALLATION

- \* Check the functioning of the anti-tamper by inserting the provided magnet in the appropriate hole (left in the figure) and monitor the output of terminals 3/4
- \* Use the cable retention plate to fix the cable
- \* Assemble the sensor with the cable exit on either side of the aluminum case, unscrewing the two stainless steel screws on the back of the sensor, as shown in the picture.
- \* You can protect the cable with:
  - \* the short cable exit;
  - \* a plastic, 8mm internal diameter sheath which will fit exactly the long cable exit accessory;
  - \* the stainless steel, reinforced sheath TSec part no. CLH-2G.

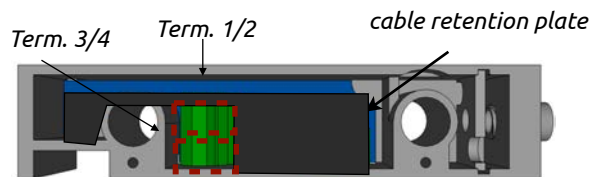

## 4. IN-LINE INSTALLATION: WORKING GAPS IN mm

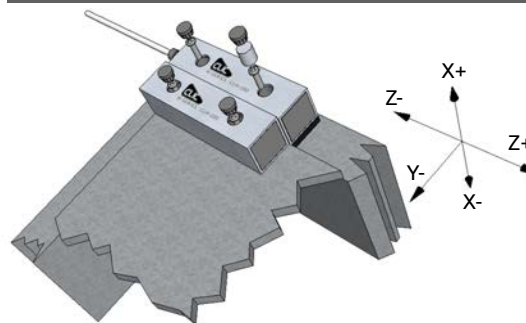

Axis	Action	Dist. no iron	Dist. iron
Z+	Removal	30*	25*
	Approach	20*	18*
Z-	Removal	25*	23*
	Approach	18*	18*
X+	Removal	22*	24*
	Approach	15*	18*
X-	Removal	22*	24*
	Approach	15*	18*
Y-	Removal	20	20
	Approach	12	12

\*Considered at nominal distance D=8mm

- \* The contact is shipped with the magnet already assembled for in-line installation.
- \* Position sensor and magnet according to the figure.
- \* Place the pry-tamper magnet in the hole opposite to the cable exit side.
- \* Note that screw caps are anti-tamper, and should be positioned only after testing is complete.
- \* To obtain a maximum security installation, it is recommended that: the operating distance between sensor and magnet is minimised.



# High security anti-masking magnetic contacts CLH-201-M



## 5. PREPARING THE MAGNET FOR RIGHT-ANGLE INSTALLATIONS

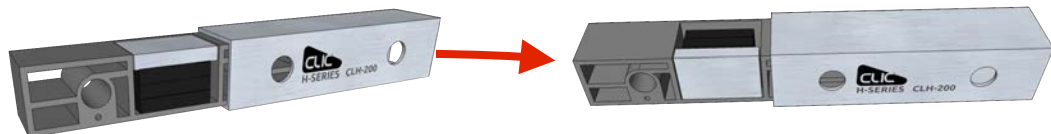

Magnet assembled for in line installation (default)

Magnet assembled for right-angled installation

## 6. RIGHT-ANGLED INSTALLATION: WORKING GAPS IN mm

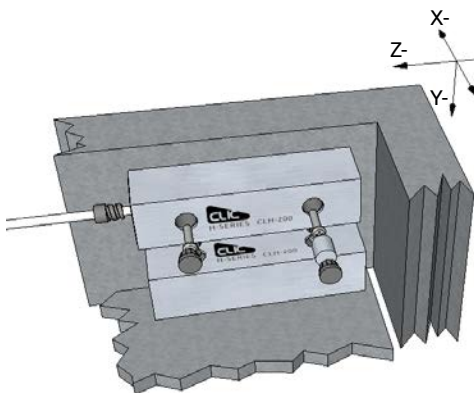

- \* Re-assemble the magnet for horizontal installation (see previous section)
- \* Position sensor and magnet according to the figure.
- \* Place the pry-tamper magnet in the hole opposite to the cable exit side.
- \* Note that screw caps are anti-tamper, and should be positioned only after testing is complete.
- \* To obtain a maximum security installation, it is recommended to minimise the distance between sensor and magnet.

Axis	Action	Dist. no iron	Dist. iron
Z+	Removal	30*	22*
	Approach	20*	16*
Z-	Removal	25*	23*
	Approach	18*	18*
X+	Removal	22*	22*
	Approach	15*	15*
X-	Removal	22*	22*
	Approach	15*	15*
Y-	Removal	20	20
	Approach	12	12

\*Considered at nominal distance D=8mm

## 7. INSTALLATION ON SLIDING DOORS

- \* Installation on sliding doors requires mounting sensor and magnet as shown in the picture below on the left. The exit cable side and the sliding door have the same direction.
- \* Alternatively, install the contact vertically, so that when the door is opening and closing, the magnet does not slide from/to the sensor.

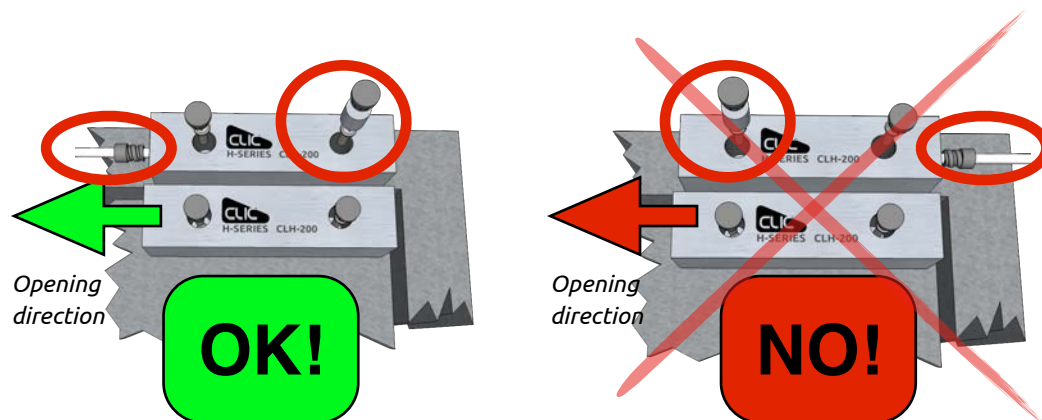

## 8. OPTIONAL ACCESSORIES

- \* One way, stainless steel, self tapping screws part no. **CLH-1S**.
- \* For maximum security, we recommend installing the reinforced, stainless steel sheath part no. **CLH-2G10**.
- \* For installation on safes and armored panels, use accessory iron supports w/ one-way security screws, part. no. **CLH-2MF**, for easier installation.
- \* When it is absolutely necessary to work with a larger operating gap, use the accessory magnet, part no. **CLH-2XT**, adding it to the magnet as shown in the picture below. Note that in this case certification according to EN50131 will be void.

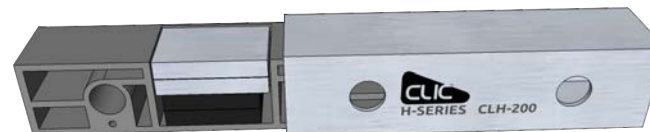

TSEC S.p.A.  
www.tsec.it  
info@tsec.it



EN50131-2-6  
GR 3 - CL II